

XFORM

DESIGN + ENGINEERING

Every 16 seconds one of our designed products is sold.

With more than 23 YEARS of experience, XFORM is an Industrial Design firm working side by side with companies developing innovative products with an integrated approach.

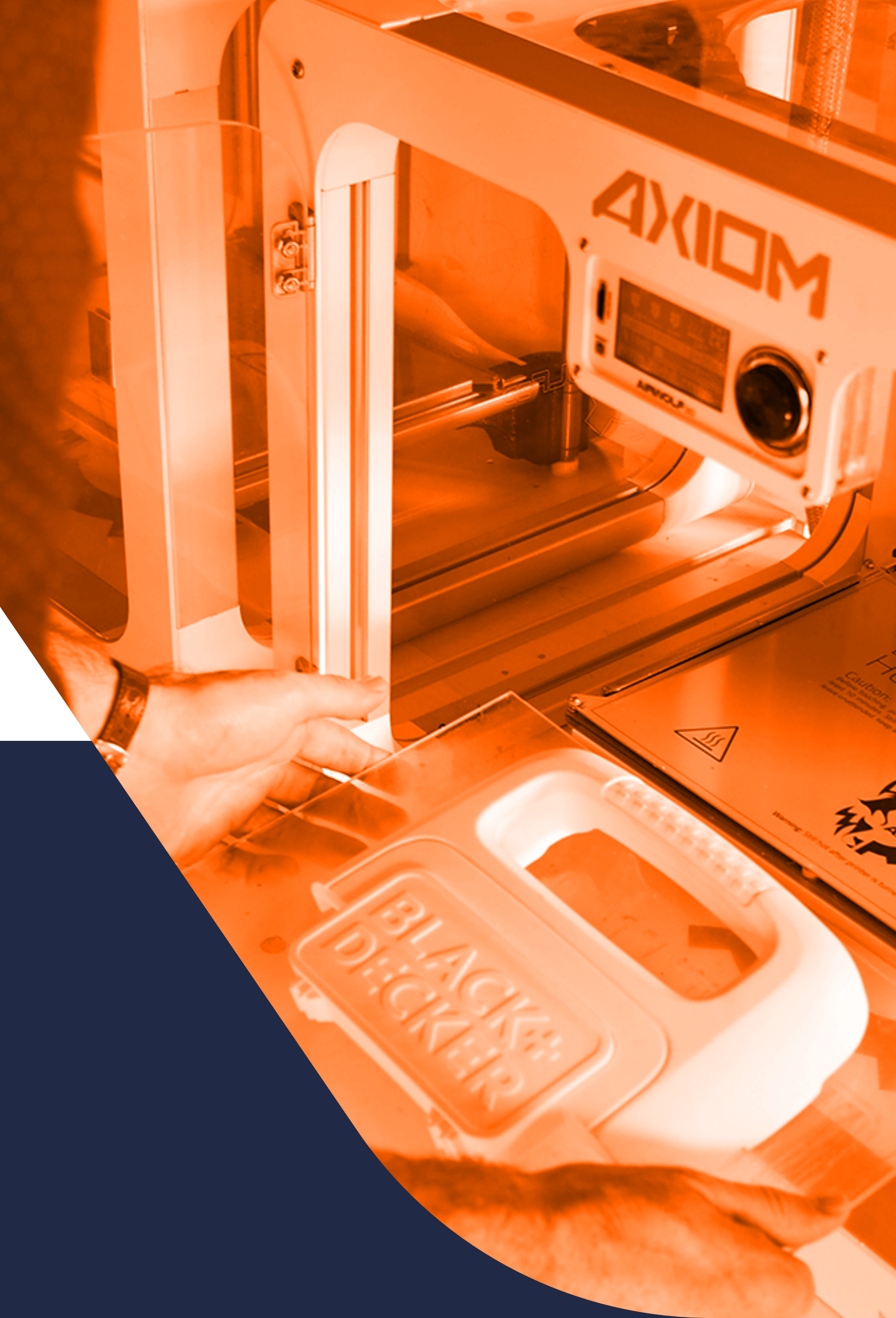

Our Story.

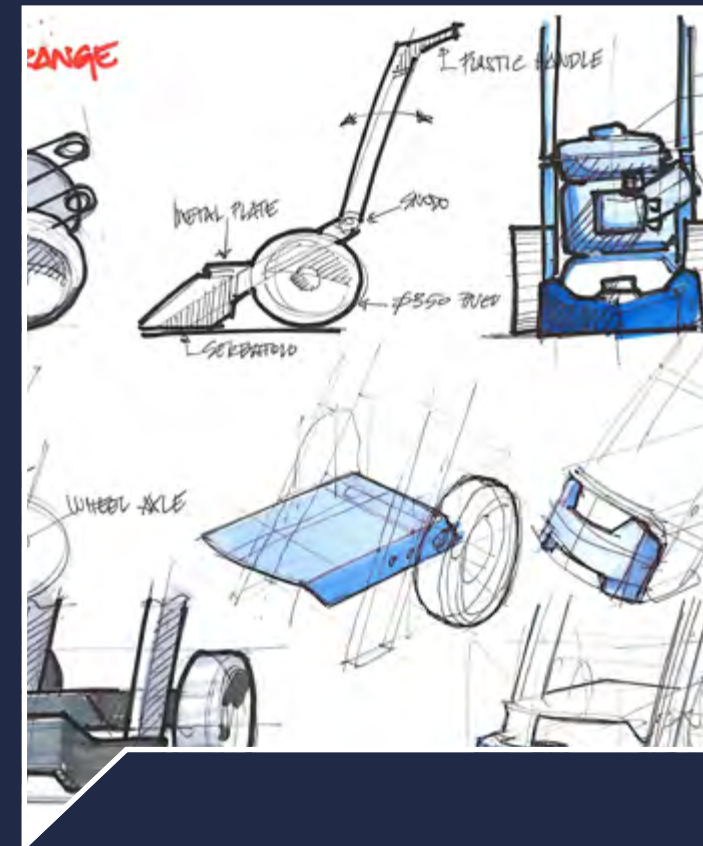

2000

FOUNDED IN REGGIO EMILIA
Our expertise: projects development
for mass production.

2002

CLEANING INDUSTRY
High Pressure Washers to
Vacuum Cleaners.

2003

DESIGN TESTIMONIAL
Selected by SIEMENS for
the launch of Unigraphics
NX CAD products.

2004

HEALTHCARE AND
AUTOMOTIVE INDUSTRY

2007

NAUTICAL INDUSTRY
Azimut Benetti Yachts
and Ultraflex nautical
accessories.

We have nurtured our know-how through diversified experiences.

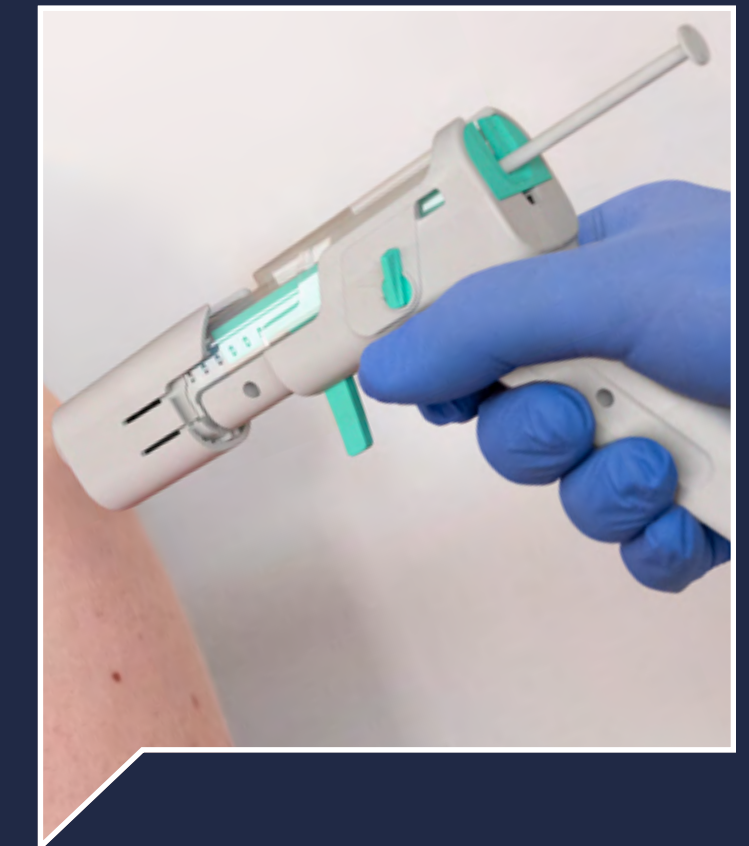
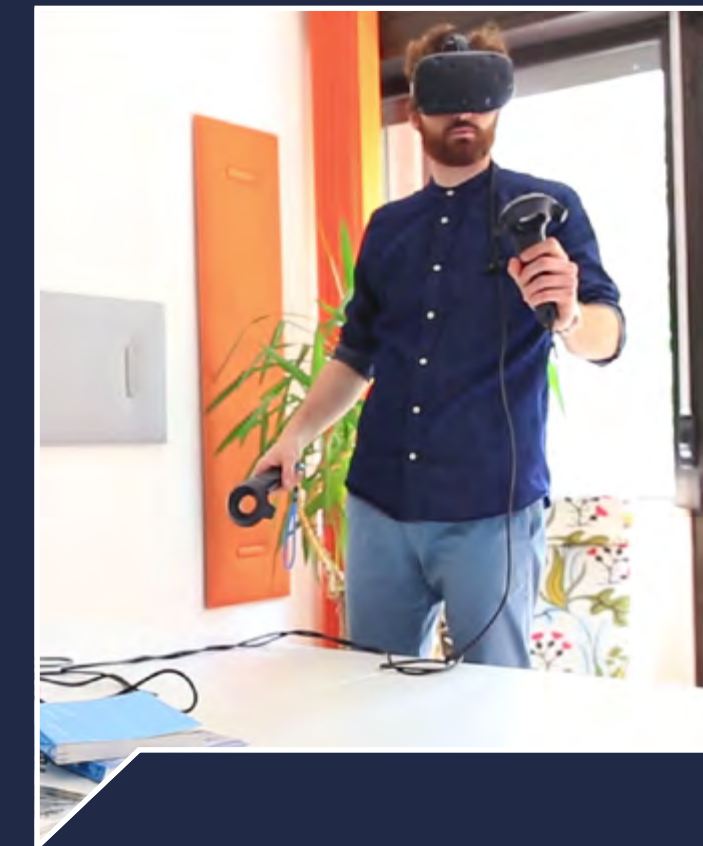
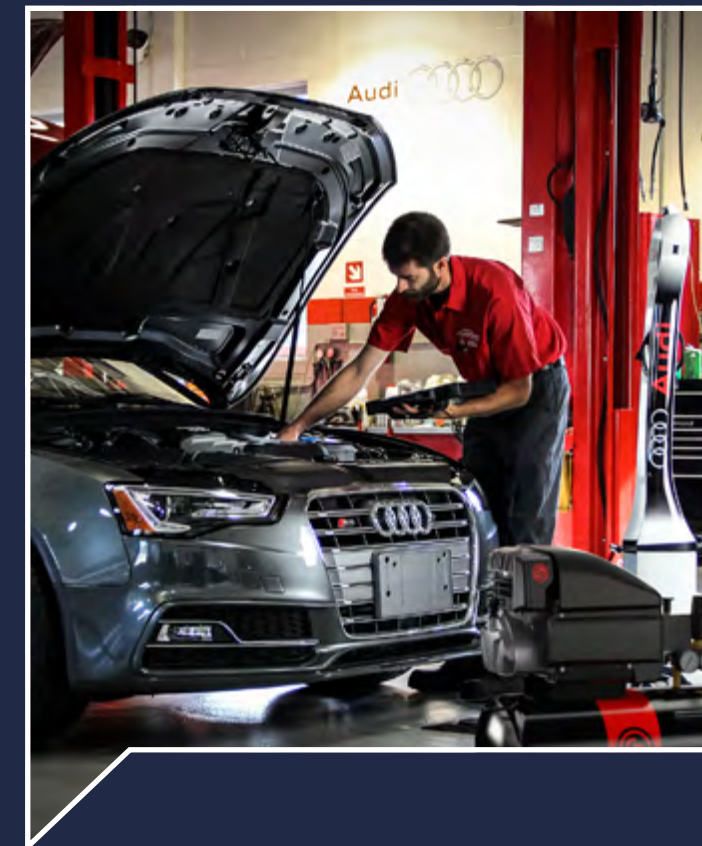
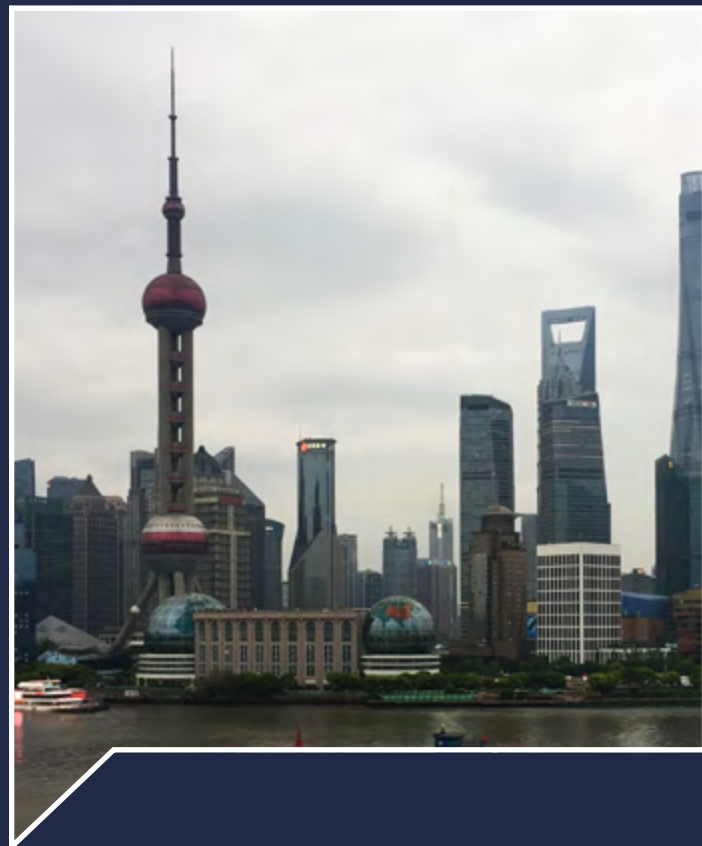

2014

SHANGHAI OFFICE
An active presence in China was strategic for management.

2015

BUYOUT PROJECTS
Customizing products for Stanley Black&Decker.

2016

INHOUSE PROTOTYPING
6 FDM 3D Printers handling a variety of output formats.

2017

ATLAS COPCO
World-leading provider of sustainable productivity solutions.

2017

VR & AR EXPERIENCES
Presented during the China International Boat Show in Shanghai.

2020

Joining the COVID-19 fight
XFORM designed an injection device for IGEA Medical.

More than **1200** products designed
& engineered for mass production.
More than **100** clients worldwide.

We have worked with: Abac, AEG, Angiodynamics, Annovi Reverberi, AR North America, Aquamot, Atlas Copco, Audi, Azimut Benetti, Black&Decker, Bosch, Breda Menarini, Chicago Pneumatic, Citroen, Corgi, Comet, Conspiracy, Contardi, Daewoo, Davide Groppi, DeLonghi, DeWalt, Ducati, Ducar, Erbauer, Exprimo, Fiac, Fiat, Greenworks, IGEA Medical, Hitachi, JBC, Lavor, Ledeshi, Linhai, Makita, Michelin, Nuair, OK Baby, Prima Light, RCF, Ryobi, Smeg, Spark Security, Stanley, Steel Cucine, Tiya, Ultraflex, ViaTouch, VipItalia, Volvo.. and more.



Integrated data structure & shared workflow.

Project Management.

Project Management is at the core of every process and project allowing us to keep control over activities, coordination between internal and external stakeholders, manage flawlessly licensor validation steps.

- ↘ Project planning
- ↘ Business plan development
- ↘ Supplier evaluation
- ↘ Certifications
- ↘ Team activities coordination
- ↘ License validation management

Product Development.

We blend vision and precision with focused creativity. Precision engineering is at the heart of our process. We prototype and define samples following all the validation process. It's our expertise.

- ↘ Benchmarking & analysis
- ↘ Product test
- ↘ Concept design & engineering
- ↘ Prototyping
- ↘ Samples validation
- ↘ Mass production startup

Marketing Support.

Marketing support is strategic throughout the whole project development process: from early product presentations to events planning for product launch. We provide the tools to win today's market competition.

- ↘ Product visualization
- ↘ Product presentation
- ↘ Catalogues & brochures
- ↘ Product packaging
- ↘ Video production
- ↘ Digital presentations

Our process.

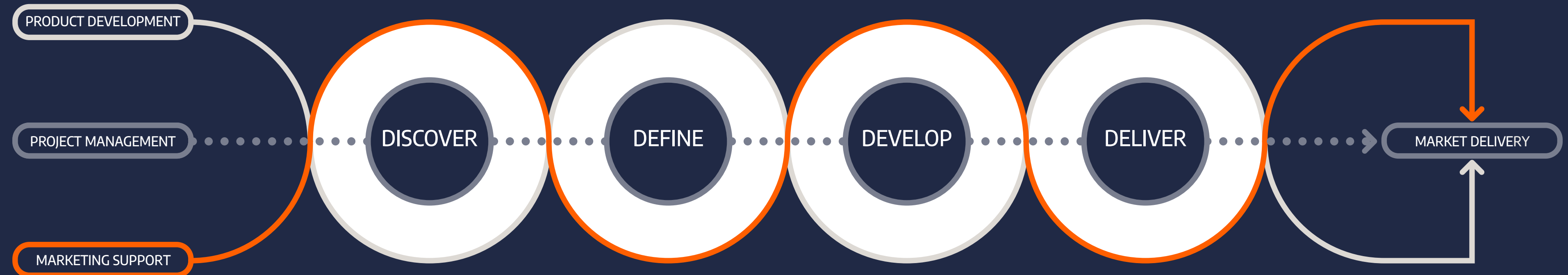

Design, Engineering and Marketing Services are fully integrated and directly related to each other and to our customers since the very beginning of the process.

We explore the problem and learn about it. We investigate previous solutions and look for opportunities that could lead to a new idea. What are the challenges?

We share ideas and confront solutions, build rapid prototypes to test ergonomics. We set priorities among features and try to balance the costs. This is a refinement process.

In order to shorten Time to Market, we start to develop product labels, stickers, packaging. We test the market with mockup presentations and we make a few adjustments.

We sample, with our selected supplier, the product and test its quality and performance. We proceed with mass production tuning communication.

Our services.

Beyond product design:
we empower strategies.

Every project starts with a problem to solve. Design explores the limits and problems we face in our activities and while interacting with products and tools. There is no perfect design but multiple solutions we can test and evaluate partnering with the client.

Through engineering we transform the design solution into a digital prototype and we analyze the model under many points of view.

We build and test prototypes and refine them, collaborate with suppliers during the process and take care of it up to production.

Design+Engineering create aesthetics for the real world.



BRANDING STRATEGY



Our assets: 3 offices, 10 people.

- 2 Administration & Operations
Project Management
- 1 Research
& Development
- 5 Design
& Engineering
- 1 Communication
& Marketing
- 1 Supply Chain
Support

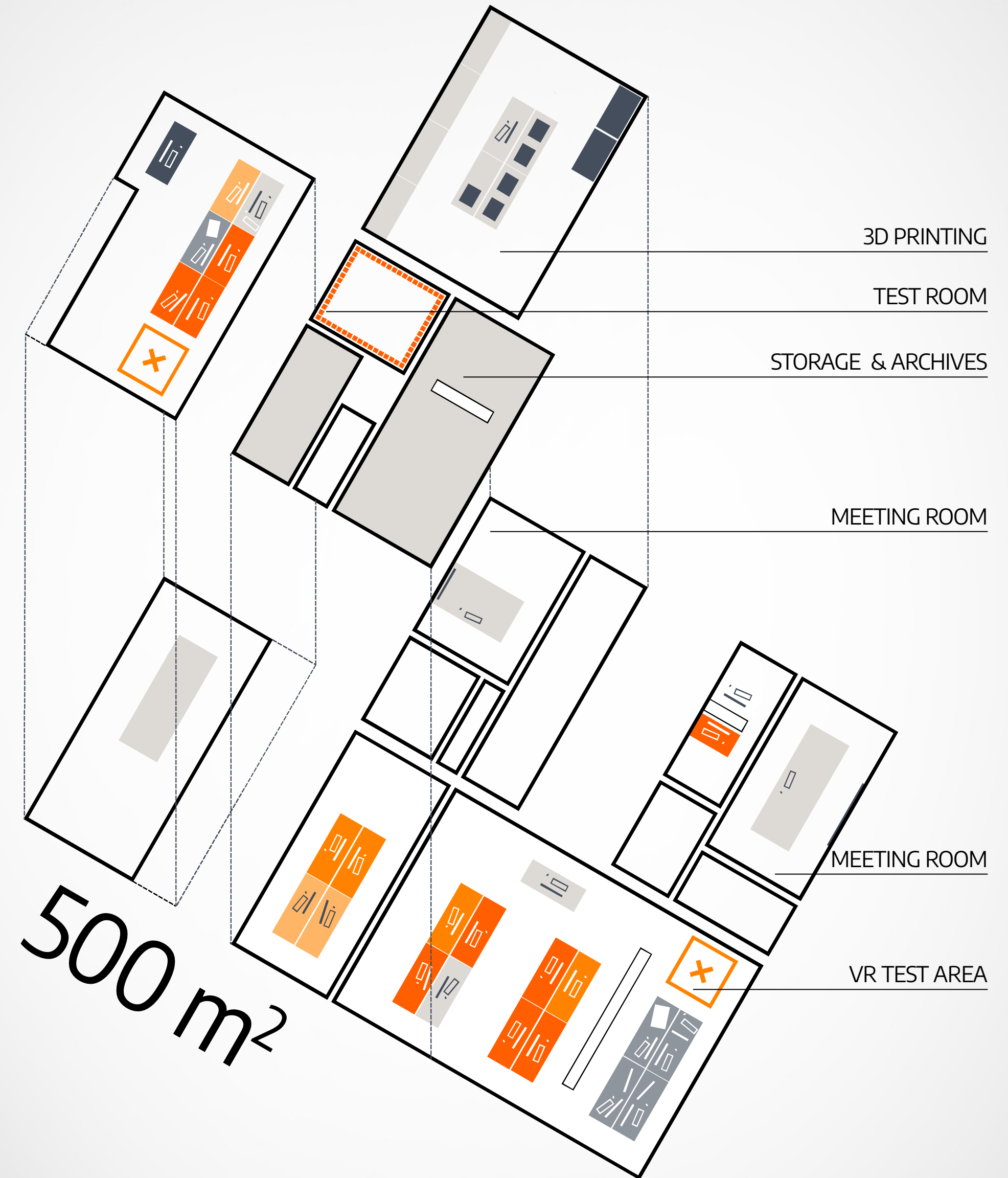

We have a 360° experience.



Kitchen Appliances
Safety Baby Seats
Electro Medical Appliances
Home Cleaning Equipments
High Pressure Washers
Vacuum Cleaners
Garden Pumps
Professional Lawn Mowers
Water Cleaning Systems
Welding Systems
Air Compressors
Engines

by PRODUCTS

Cell Phone Accessories
Portable Coolers
Portable Toilets
Camping Lamps & Stoves
Armoured Doors
Snow Blowers
Cement Mixer
Wheel Balancers
Vehicles
Car Accessories
Interior & Exterior Lighting
Yachts

by INDUSTRY

Agriculture
Automotive & Nautical
Communication
Consumer Durables
Gardening
Heavy Industry
Houseware
Lighting
Medical
Power Tools
Professional Equipment
Safety Equipment

Cleaning Appliances

Clients:

Annovi Reverberi, AR North America, Black+Decker, Bosch, Comet, Stanley, DeWalt, Fini, Greenworks, Hozelock, Kyowa, Lavorwash, Lutian, MacAllister, Makita, Michelin, Maxeda, Ryobi, Sistema, Sterwins, Stihl, Yili



Water Pumps

Clients:
Annovi Reverberi, Black+Decker, Stanley

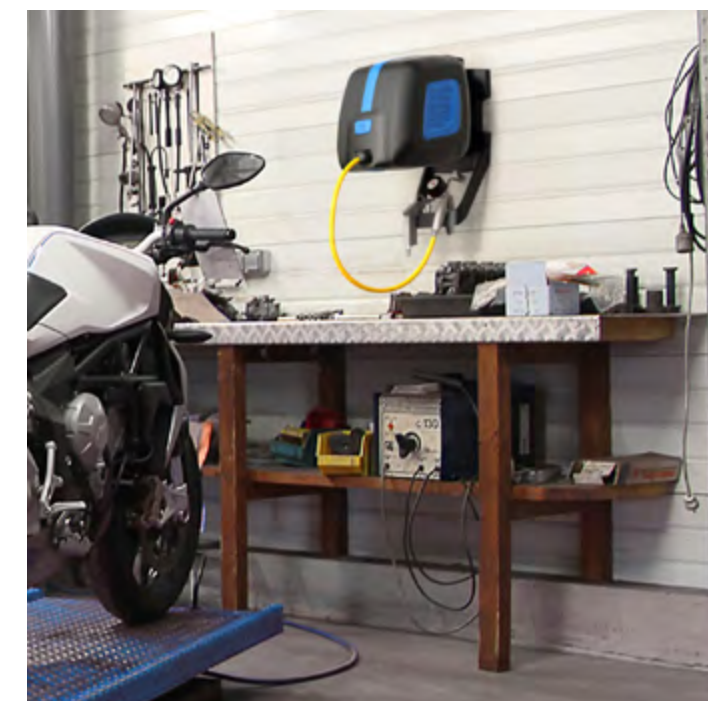

Air Compressors

Clients:
Abac, AEG, Atlas Copco, Black+Decker, Campagnola,
Fiac, Fini, Hitachi, Michelin, Pressure

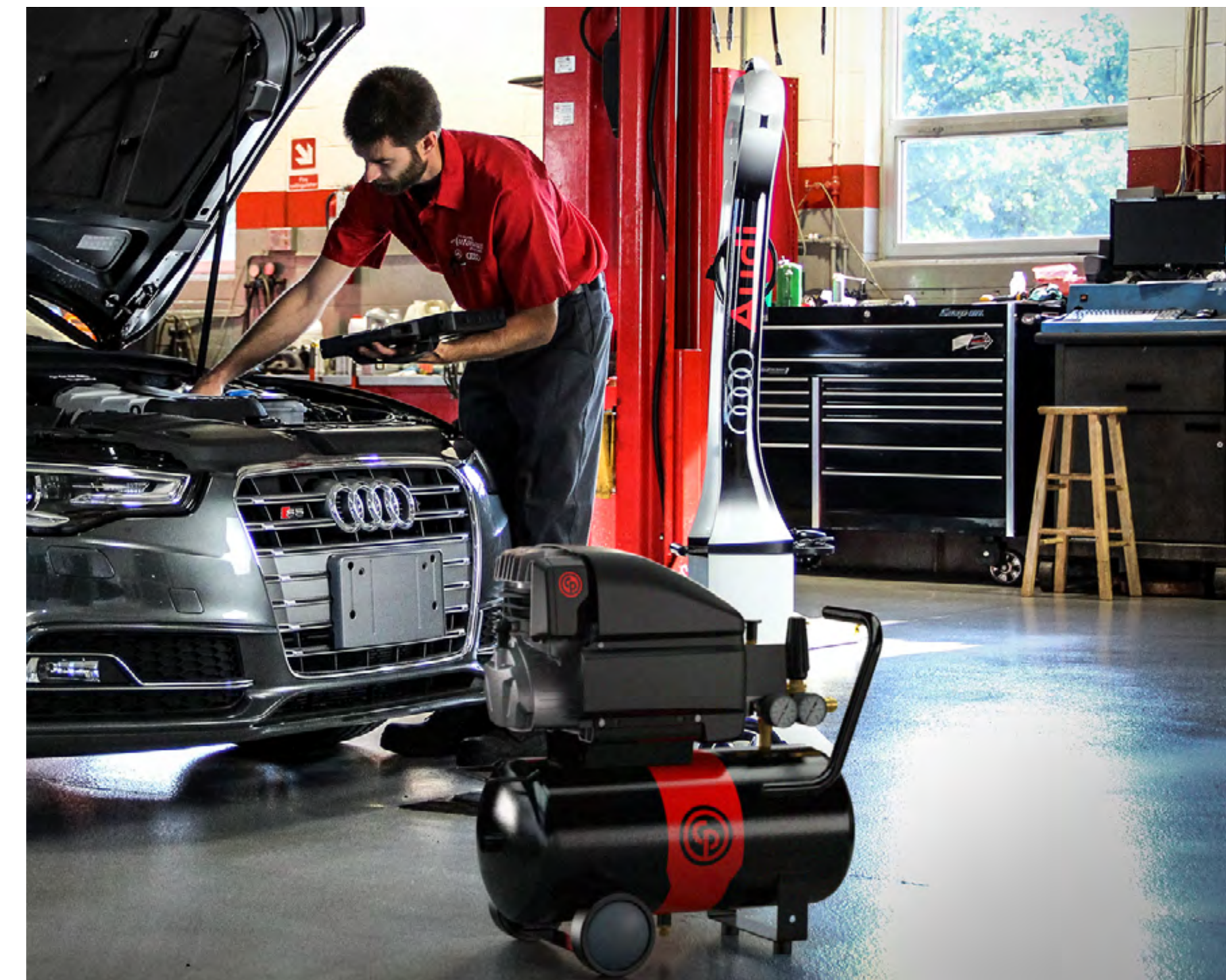

Garden Tools

Clients:
Dayee, Ducar, Emak, Eurosystem, Globe,
Greenworks, Primaster, Senci, Sunseeker

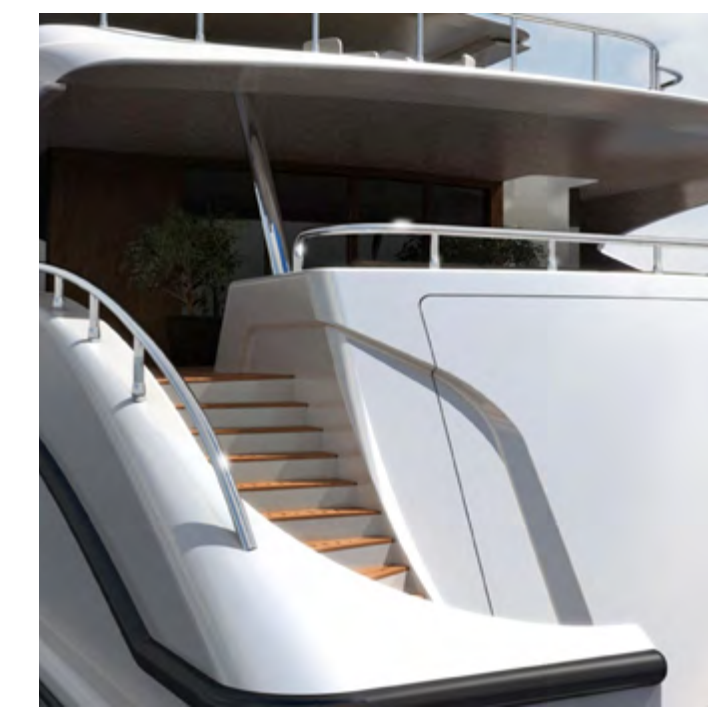

Automotive & Nautical

Clients:
Audi, Azimut Benetti, Breda Menarini, Citroën,
Ducati, Fiat, Linhai, Maserati, Ultraflex, Volvo

Kitchen Appliances

Clients:
Barilla, De Longhi, Sopralco, STEEL Cucine, Sirsa

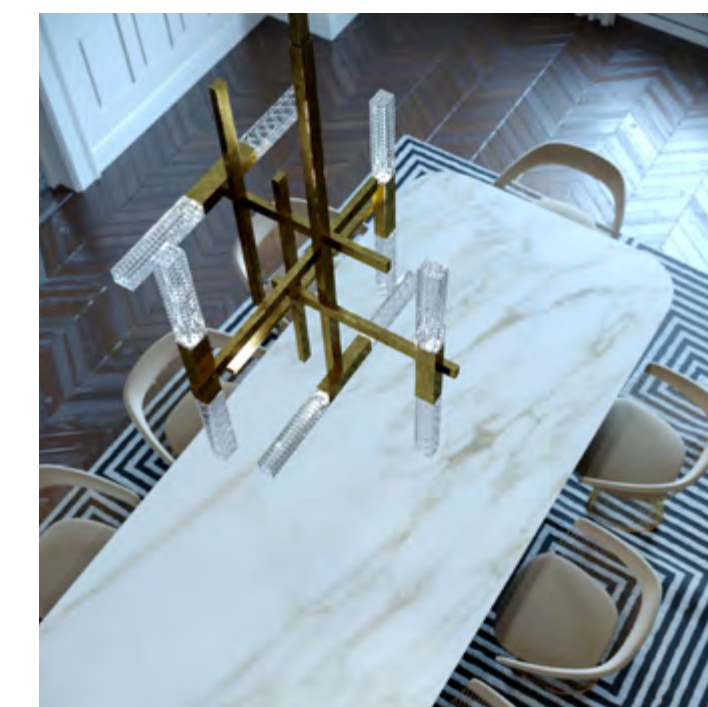
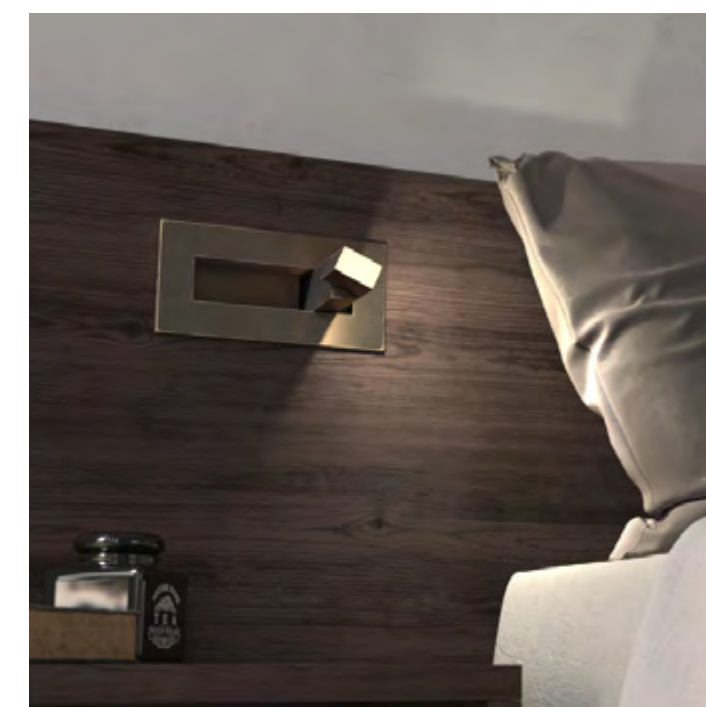

Medical & Healthcare Devices

Clients:
Angiodynamics, Igea Medical, Medichimica, Mediline,
Smeg Instruments, Viplitalia





+39 0522 337584
9, Via Gran Sasso d'Italia,
42122 - Reggio Emilia, **Italia**

+1 612 750 6702
140-81st Avenue NE, Fridley,
MN 55432, **United States**

+86 137 64858874
N°651 Jiang Ting Rd. Feng Xian district,
Shanghai 201404, **China**
www.xform.it

